



SMQT

New

Access control & Alarm product supplier



2 Color optional

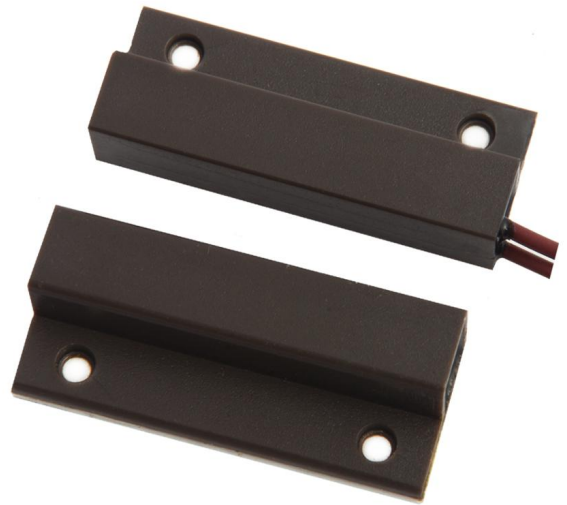
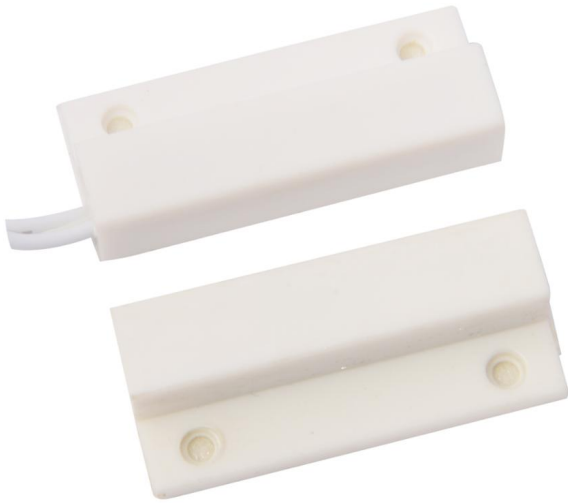

Size

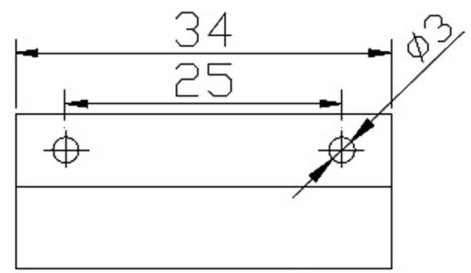
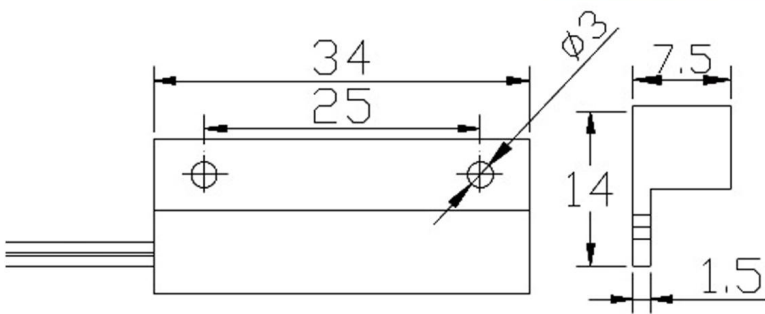
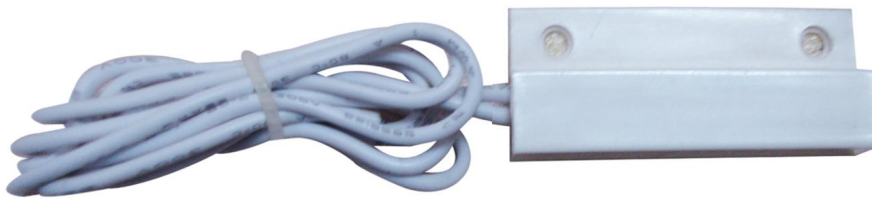

mm

NC mode working principle

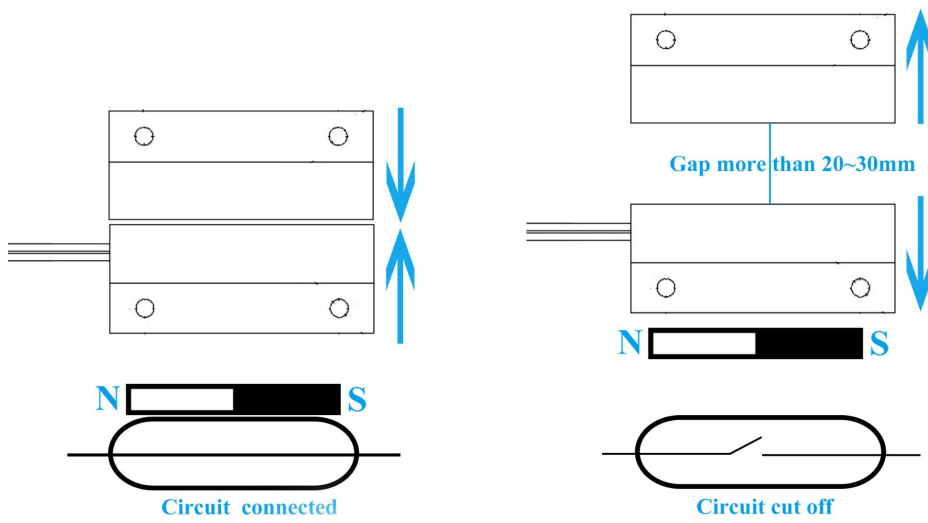

Installation

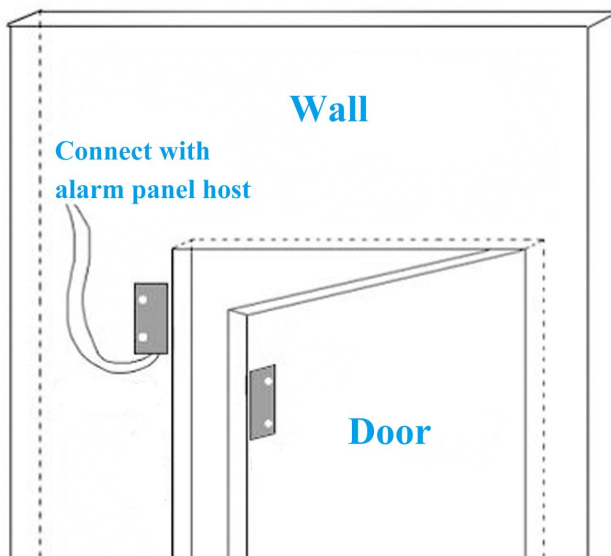

Packaging



EB-132

品名	EB-132
電源電圧	DC 100
電源電流	0.5A
消費電力	10W
端子構成	NC / COM
外形寸法	20×30mm
寸法	34 * 14 * 7.5mm 34 * 14 * 7.5mm
材質	ABS+PCB
付属品	ABS+PCB
重量	12g 20個入り250g
個数	2個
OEM	OEM

SMQT
铭汗科技

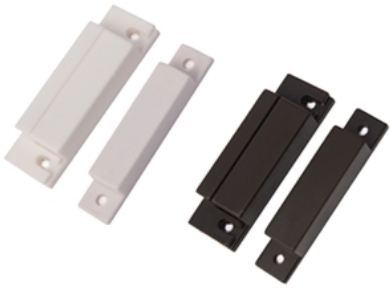

SMQT
铭汗科技

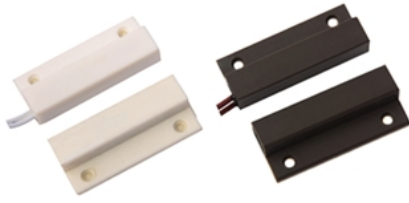

SMQT
铭汗科技

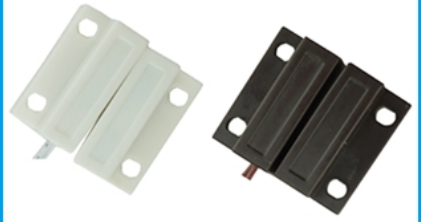

SMQT
铭汗科技

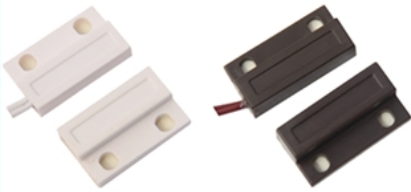

SMQT
铭汗科技



SMQT
铭汗科技

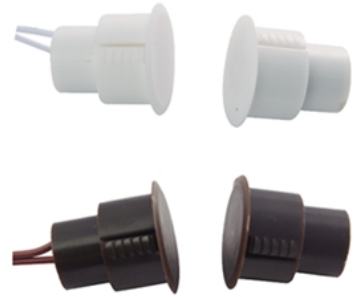

SMQT
铭汗科技



SMQT
铭汗科技



SMQT
铭汗科技

