

□□□□□□□□□□□□

SMQT®

New

Access control & Alarm product supplier



EB-139A□□□□□

□□□□	□□□□□□□□□□□□
□□□	EB-139A
□□□□	□□DC 100
□□□□	□□0.5A
□□□□	10W
□□□□	NC / COM
□□□□	□20□30mm
□□□	□□□□□106 * 16 * 16□mm□ □□□□□106* 16 * 16□□□□
□□□	□□□□□□□□
□□□	□□□□□□□□□□□□
□□□	Alloy-zn□□+ PCB□+□□□□
□□□□	□

□□□	□□5□□□□□□1200g
□□□	2□□□
OEM □	□□OEM

EB-139A□□□□□

Waterproof

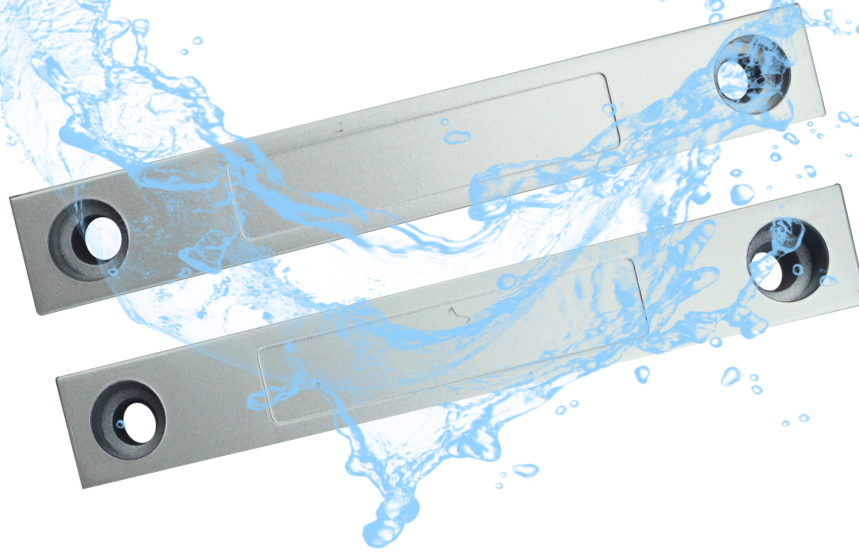

Size

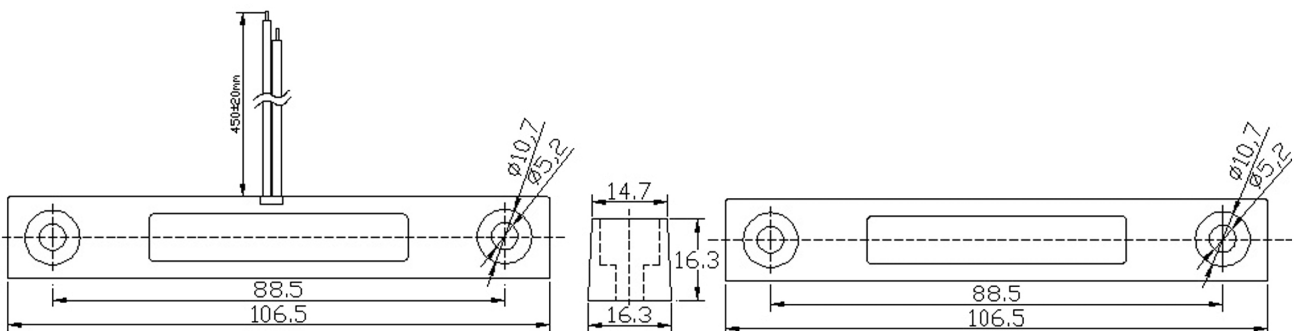

NC mode working principle

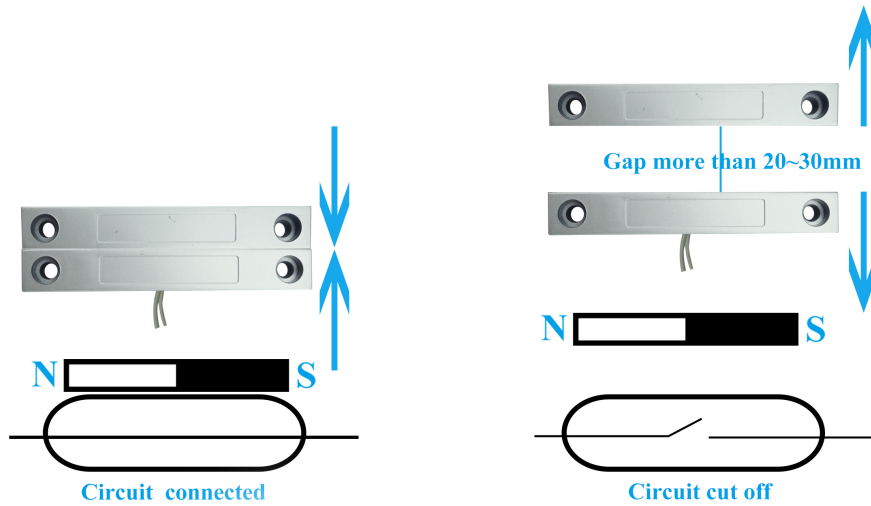

Installation

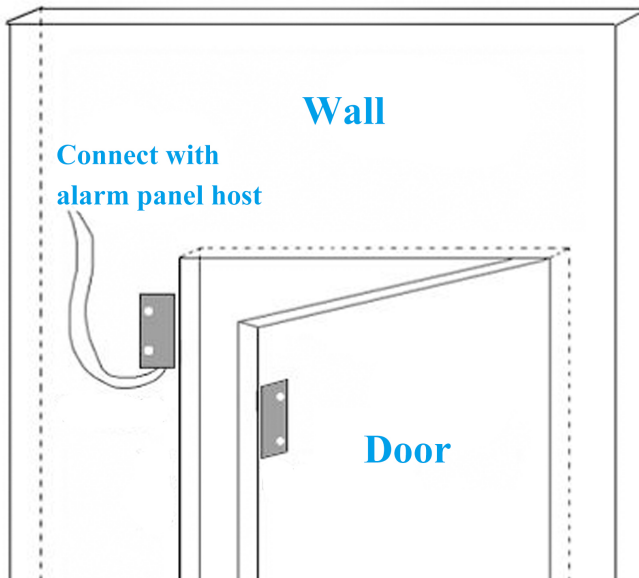

Packaging



5 pairs per bag



SMQT
铭汗科技



SMQT
铭汗科技

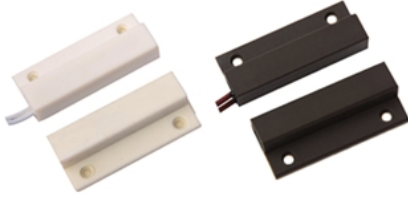

SMQT
铭汗科技

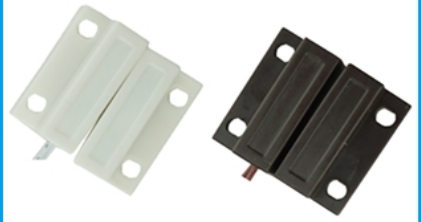

SMQT
铭汗科技



SMQT
铭汗科技



SMQT
铭汗科技

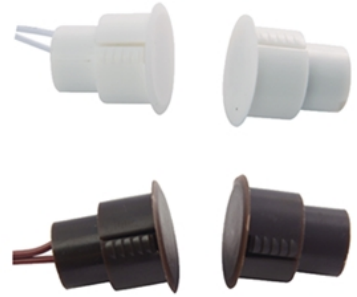

SMQT
铭汗科技

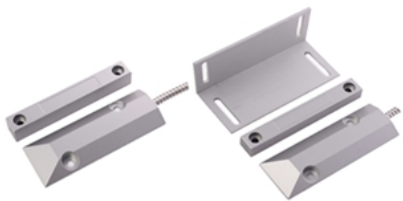

SMQT
铭汗科技



SMQT
铭汗科技

