

Sensore interruttore contatto magnetico metallo porta otturatore



PARAMETRO PRINCIPALE DI EB-137A

Nome del prodotto:	Sensore interruttore contatto magnetico metallo porta otturatore
Numero di modello:	EB-137A
Tensione di lavoro:	Max DC 100
Corrente di lavoro:	Max 0,5A
Consumo di energia:	10W
Porta di interfaccia:	NC / COM
Gap induttivo:	20 ~ 30 millimetri
Dimensione:	Parte Reed: 106 * 38 * 10 (mm) Parte del magnete: 106* 16 * 16 (mm)
caratteristica:	Utilizzo della porta dell'otturatore
Adatto a:	Tutti i tipi di sistema di controllo accessi alle porte e sistema antifurto
Materiale:	Custodia ABS + scheda PCB + interruttore Reed
Colore dell'alloggiamento:	Argento
Peso:	1 paio per sacchetto, per sacco peso 220g

Garanzia:	2 anni di garanzia
OEM:	Benvenuto OEM

ESPOSIZIONE DELLA FEATURE DI EB-137A

Waterproof

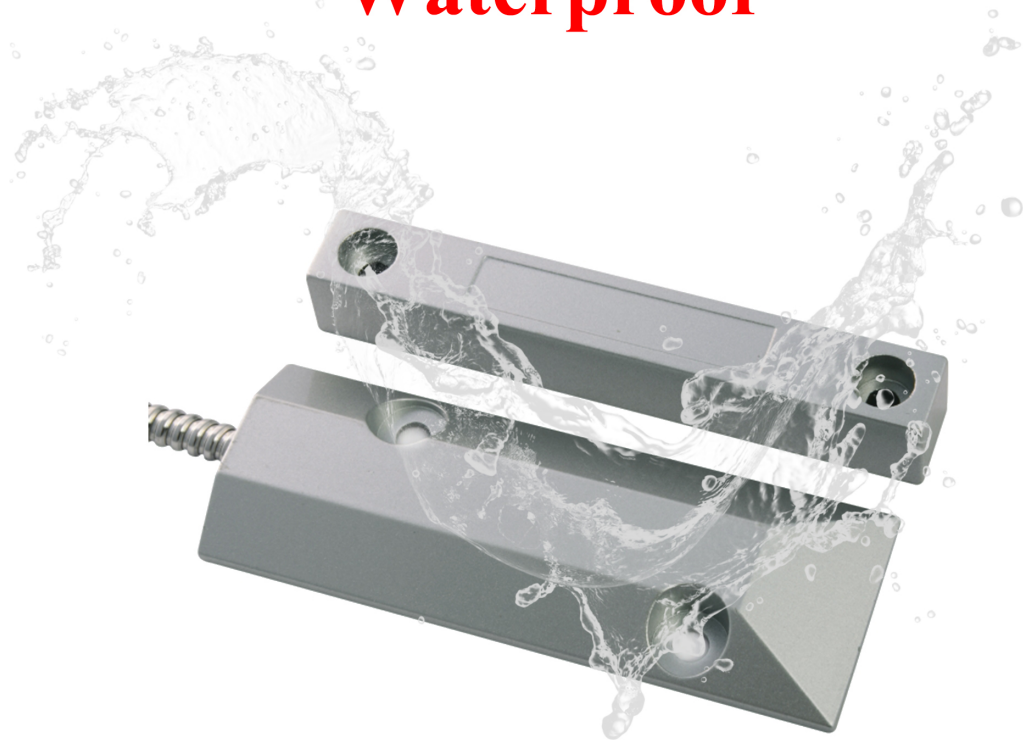

Size

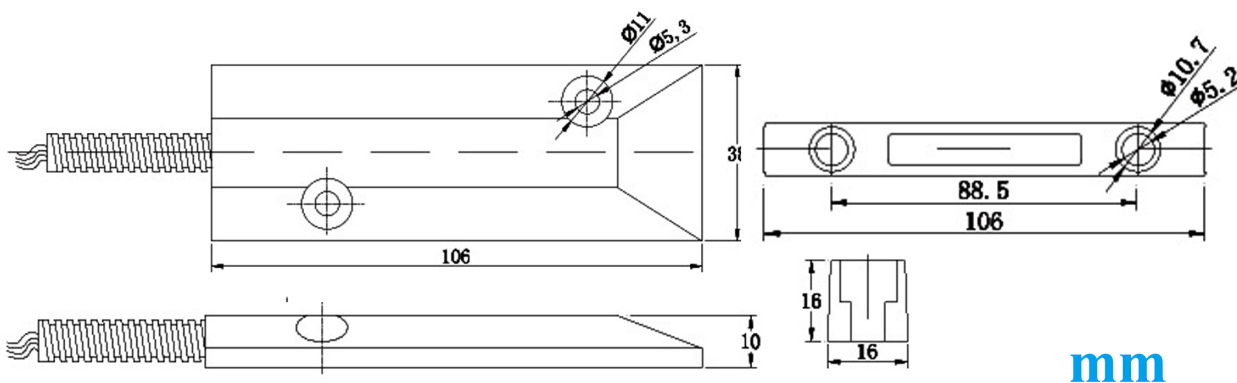
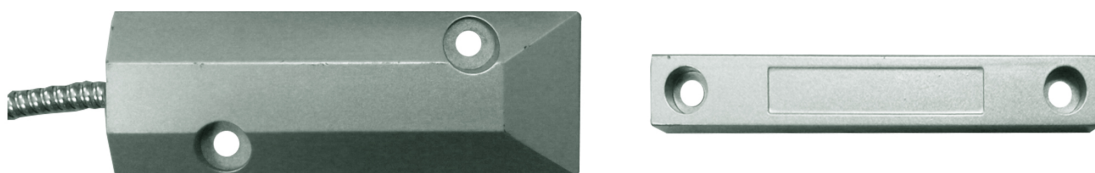

mm

NC mode working principle

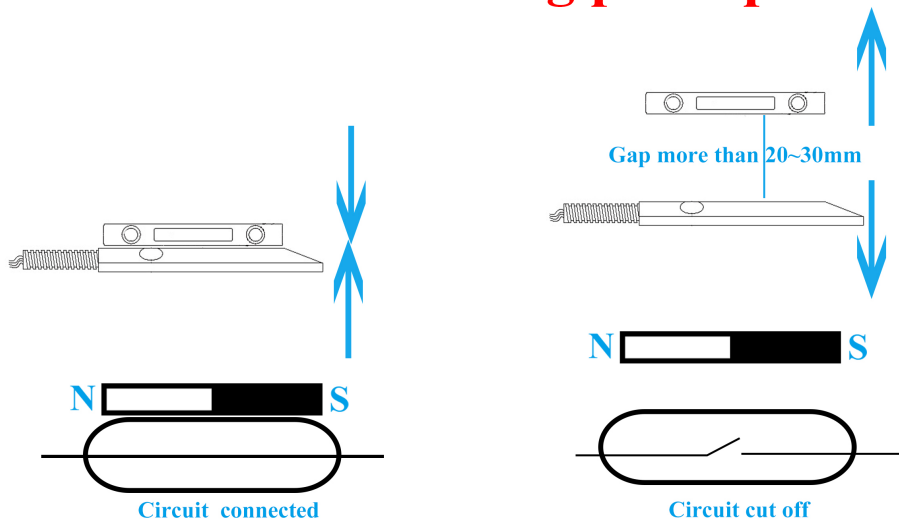

Installation

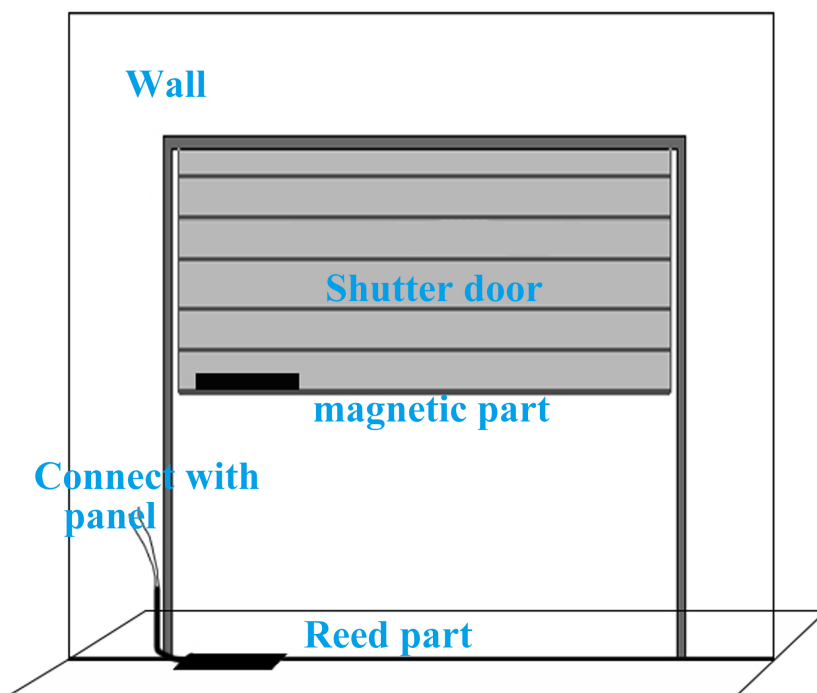

Packaging



1pairs per bag

COME DI ALTRE SCELTE?

SMQT
铭汗科技



SMQT
铭汗科技

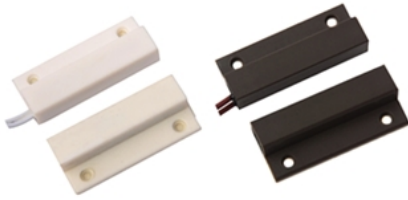

SMQT
铭汗科技

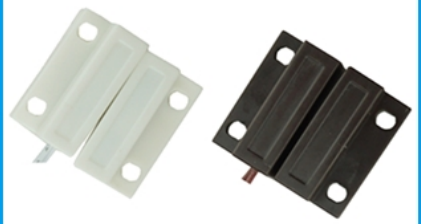

SMQT
铭汗科技



SMQT
铭汗科技



SMQT
铭汗科技



SMQT
铭汗科技

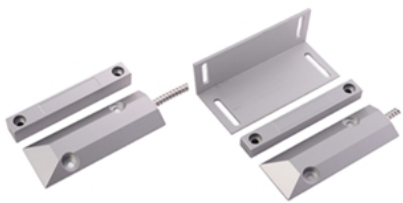

SMQT
铭汗科技



SMQT
铭汗科技

