

Nakatago ang uri ng normal na malapit na magnetic contact door sensor



EB-136'S MAIN PARAMETER

Pangalan ng Produkto:	Nakatago ang uri na normal na malapit sa magnetic contact door sensor
Modelo numero:	EB-136
Paggawa Boltage:	Max DC 100V
Paggawa kasalukuyang:	Max 0.5A
Konsumo sa enerhiya:	10W
Port ng interface:	NC / COM
Induction gap:	20 ~ 30mm
Laki:	Bahagyang bahagi: 19 (Dayametro) * 25 (H) (mm) Bahagi ng magneto: 19(Diameter) * 25 (H) (mm)
Pag-install paraan:	Naka-embed pag-install
Angkop para sa:	Lahat ng uri ng pag-access ng pinto sistema ng kontrol at sistema ng alarma ng magnanakaw
Material:	ABS housing + PCB board + Reed lumipat
Kulay ng pabahay:	Puti / Brown (opsyonal)

Timbang:	Unit timbang: 20g 10 pares bawat bag, bawat timbang ng bag 220g
Garantiya:	2 taon na warranty
OEM:	Maligayang pagdating OEM

IPAKITA ANG EB-136'S FEATURE

2 Color optional

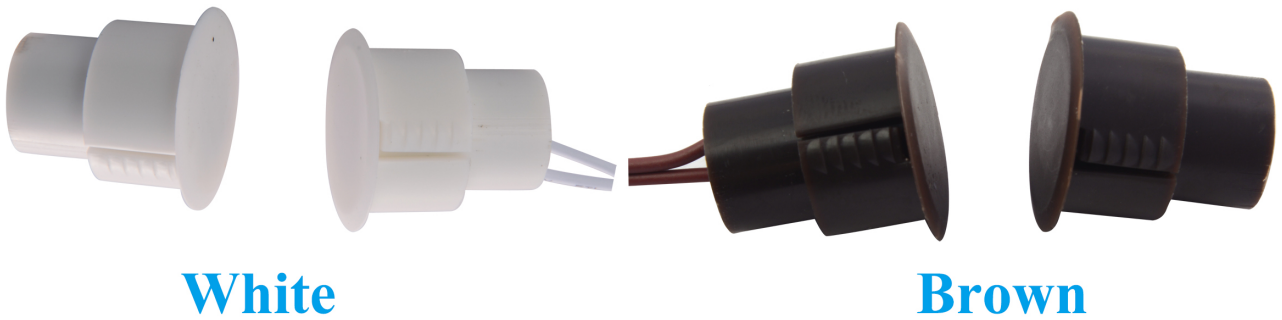

White

Brown

Size

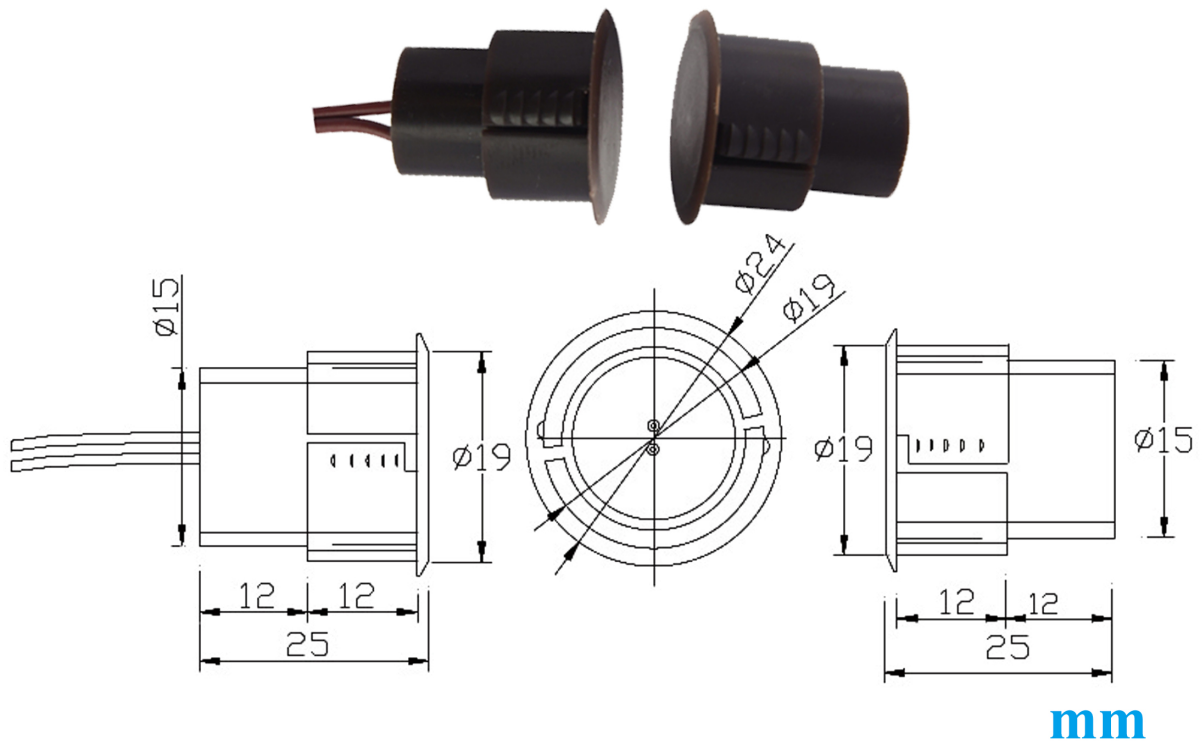

mm

NC mode working principle

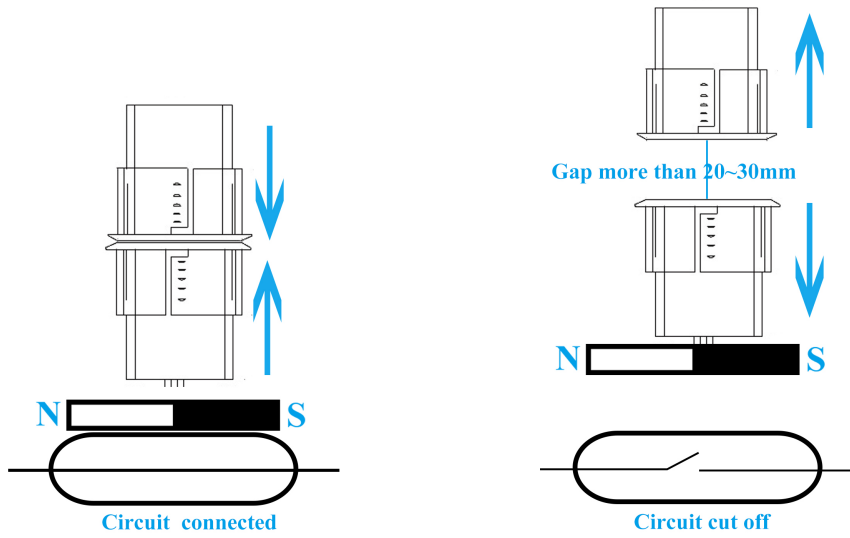

Installation

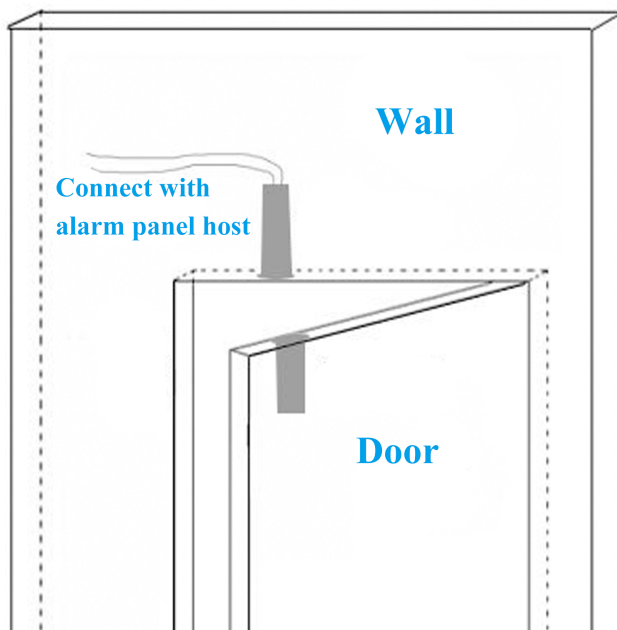

Packaging



10pairs per bag

PAANO TUNGKOL SA IBANG PILIPINAS?

SMQT
铭汗科技



SMQT
铭汗科技

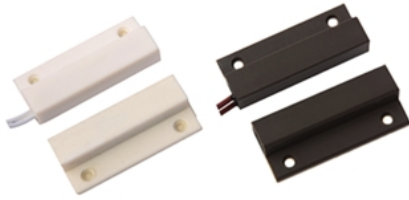

SMQT
铭汗科技

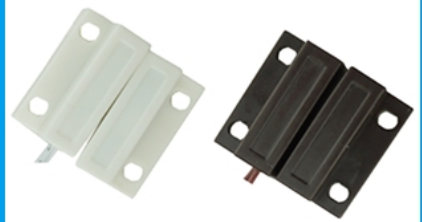

SMQT
铭汗科技

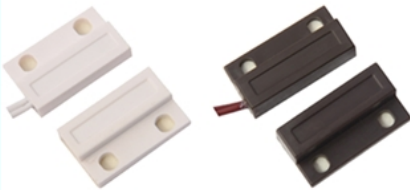

SMQT
铭汗科技



SMQT
铭汗科技



SMQT
铭汗科技



SMQT
铭汗科技



SMQT
铭汗科技

