

Hot Selling 12V / 24V One Channe Remote Controller Receiver & Transmitter

Pagpapakilala ng Produkto

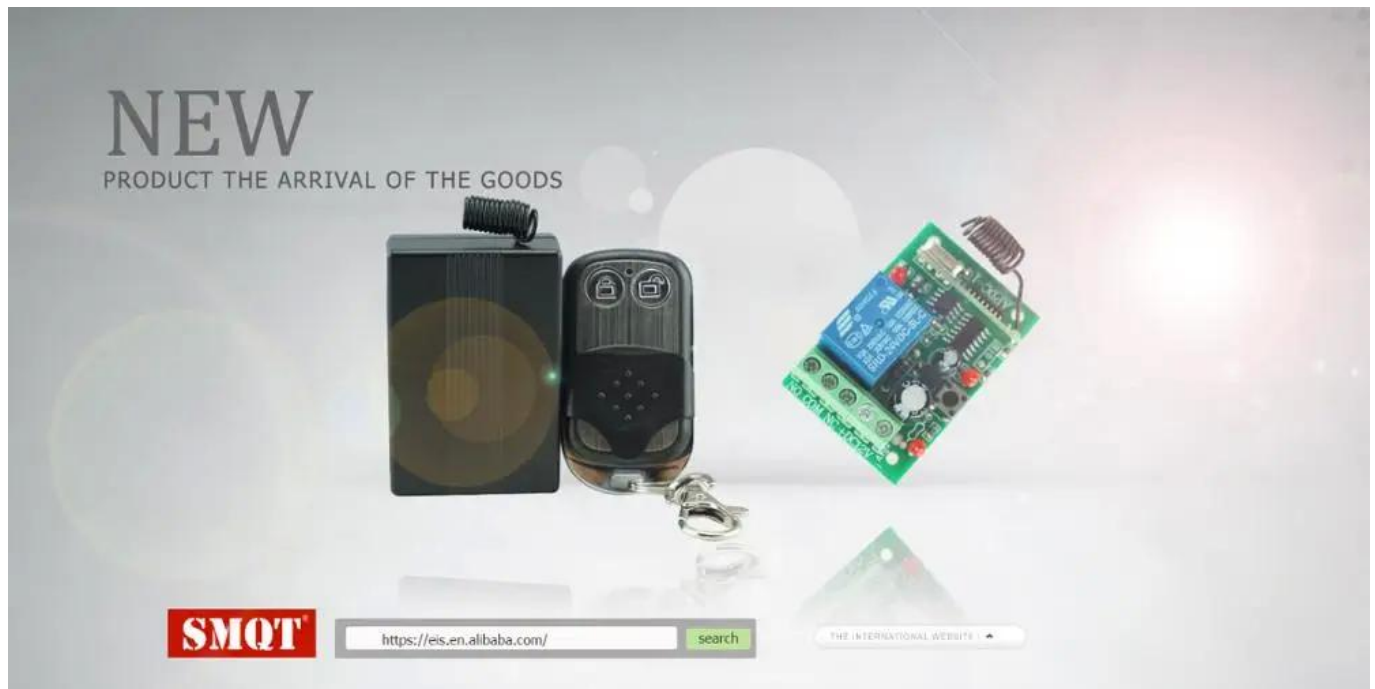

Pagtutukoy		
Pangalan ng Produkto	Hot Selling 12V / 24V One Channe Remote Controller Receiver & Transmitter	
Modelo	EA-11-1-12	EA-11-1-24
Sukat	Recevier: 65 * 33 * 24 (mm) Nagpadala: 53 * 23 * 10 (mm)	Recevier: 65 * 33 * 24 (mm) Nagpadala: 53 * 23 * 10 (mm)
Paggawa boltahe	12V DC	24V DC
Kasalukuyang Paggawa	& It; 6MA	& It; 6MA
Konsumo sa enerhiya	10mW	10mW
Max kumonekta remote controller	1 Tatanggap ng tugma max 30 pcs nagpadala	1 Tatanggap ng tugma max 30 pcs nagpadala
Wireless frequency	315Mhz / 433Mhz (opsyonal)	315Mhz / 433Mhz (opsyonal)
Distansya ng komunikasyon	100m sa bukas na hangin	100m sa bukas na hangin
Paggawa temperatura	-20 °C ~ 50 °C	-20 °C ~ 50 °C
Imbakang temperatura	-25 °C ~ 65 °C	-25 °C ~ 65 °C
Operating humidity	95%	95%
Kulay	Itim	Itim
Timbang	65g	65g

Tampok ng Produkto

Ano ang mga tampok ng aming 12V / 24V One Channe Remote Controller Receiver & Transmitter?



2 years warranty,welcome OEM&ODM

12V/24V One Channe Remote Controller

1 Receiver max match 30 pcs transmitters

Communication distance in 100m in open air

315Mhz/433Mhz(optional) wireless remote control

Display ng Produkto

IN-KIND SHOOTING

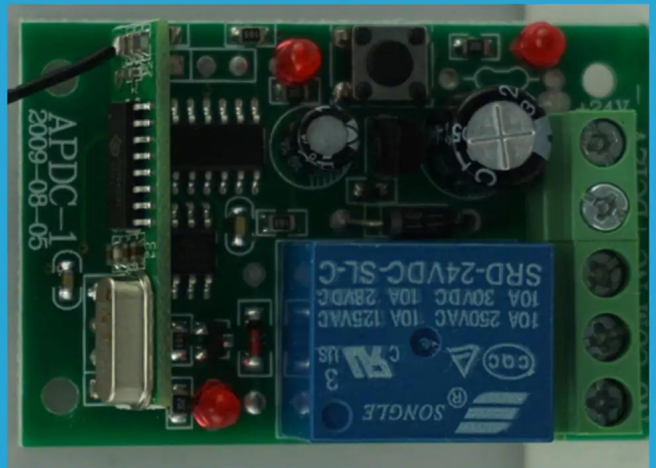
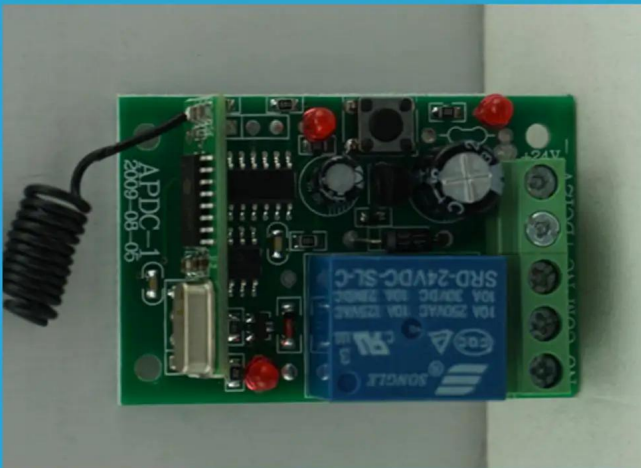

APLIKASYON

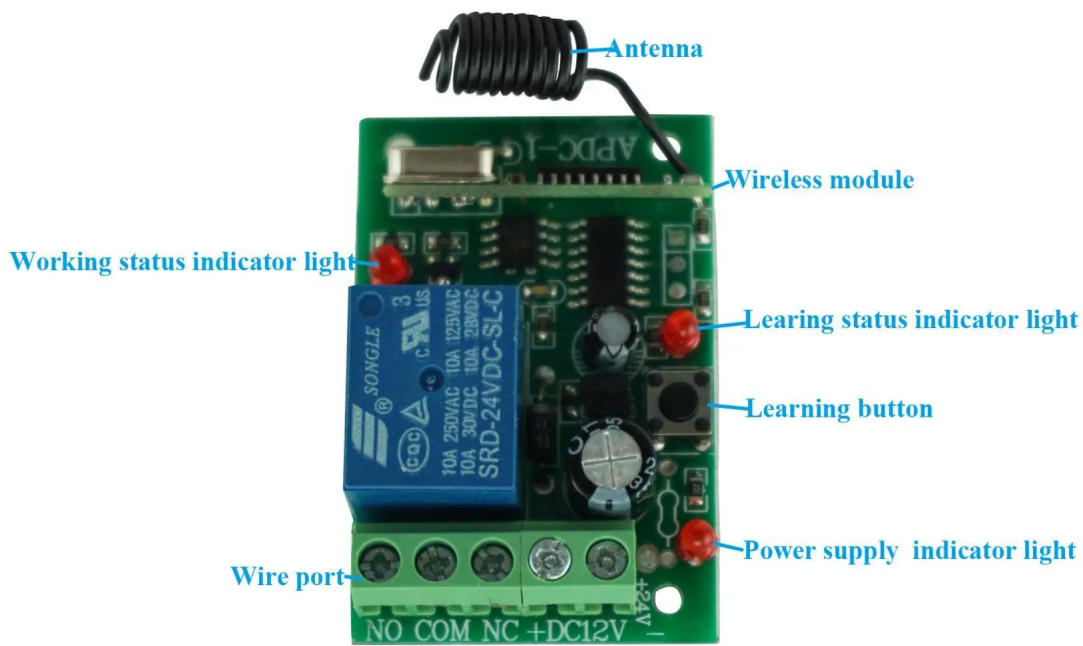

Wiring diagram:

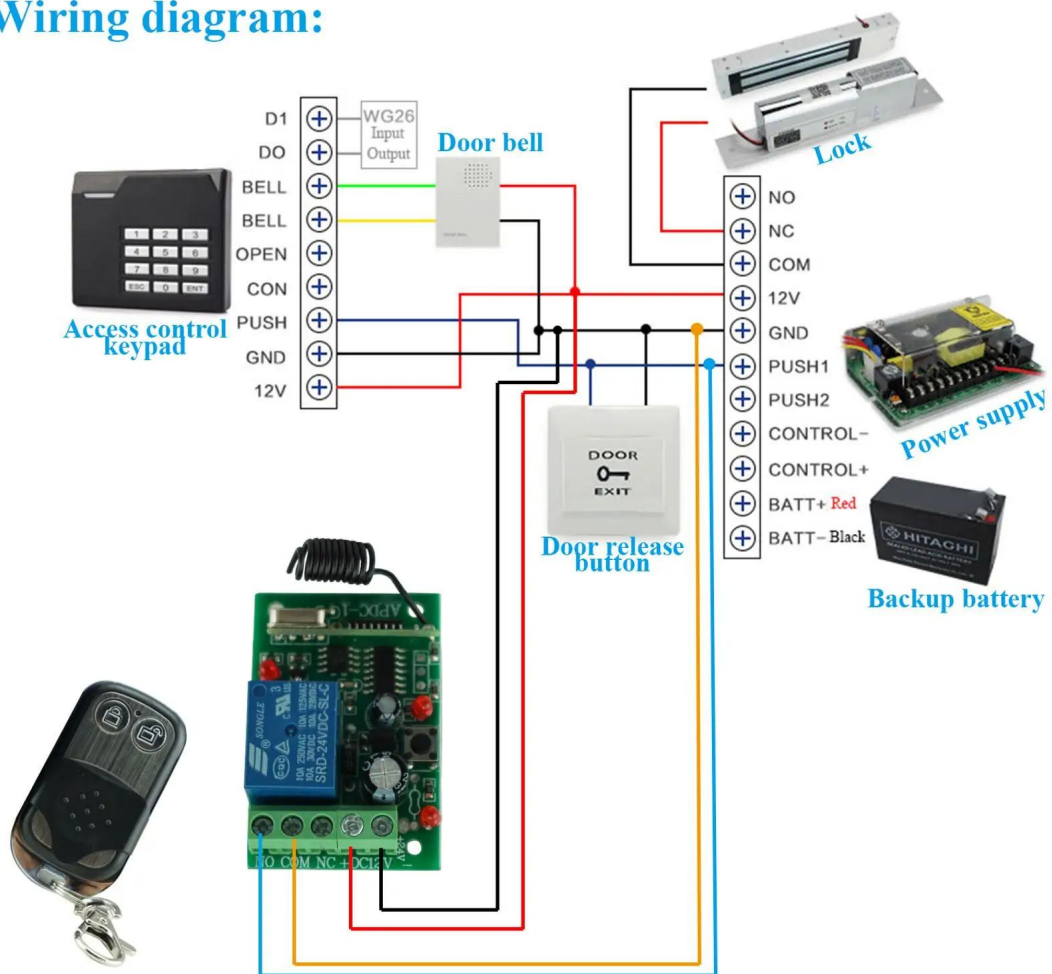

This model remote controller product is widely used in Home access control system , Apartment access control system, Garage access control system etc .

Ipakita ang Mga Kaso

IPAKITA ANG MGA KASO



Impormasyon ng Kumpanya

IPAKITA ANG TANGGAPAN



MGA CUSTOMER

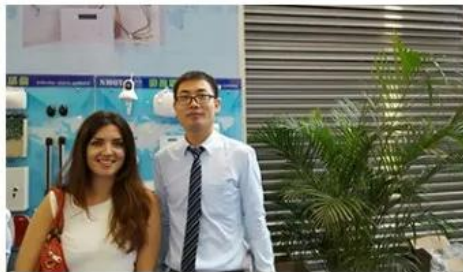

PAG-IBIG

2011 Brazil Fair



2012 shen yang Fair



2013 Jinan Fair



2013 Shenzhen Fair



2012 shen yang Fair



2013 shen yang Fair



2013 Shenzhen Fair



2015 Shenzhen Fair

SERTIPIKASYON



ang aming serbisyo

PAANO MAGAGAMIT



PACKAGING & SHIPPING

Detection+Packing+Sealing+Finishing+International Express

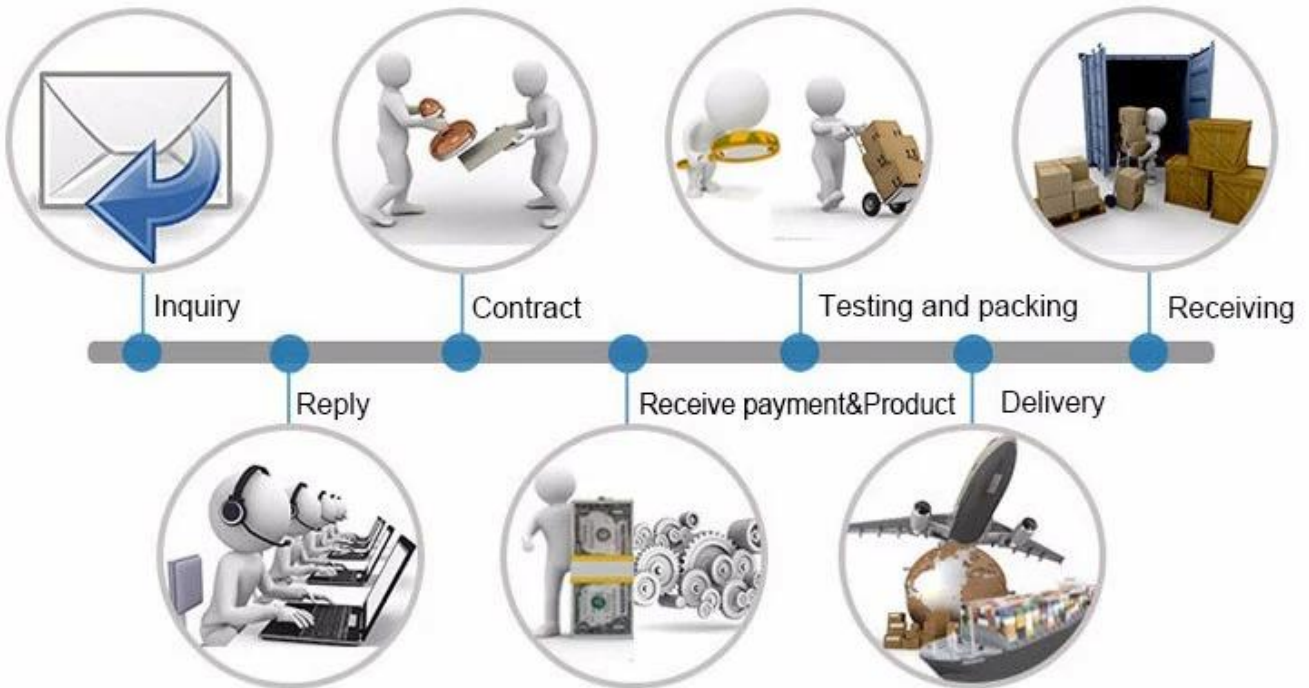

FAQ

Q: Maaari ba akong magkaroon ng sample order?

A: Oo, handa kaming mag-alok ng sample order sa iyo para sa kalidad ng pagsubok. Ang mga halo-halong sample ay katanggap-tanggap.

Q: Ano ang lead time?

A: Ang sample ay nangangailangan ng 1-3 araw ng trabaho, ang oras ng mass production ay nangangailangan ng 10-15 araw ng trabaho.

Q: Ano ang iyong MOQ?

A: Walang limitasyong MOQ. Mas maraming dami ang mas maraming diskwento.

Q: Paano mo ipapadala ang mga kalakal at kung gaano katagal dumating ito?

A: Ang sample ay ipapadala sa iyo sa pamamagitan ng opsyonal na serbisyo sa pagpapadala (courier, air, at dagat), o itinalaga ng mamimili, 7-15 araw.

Q: Paano namin magpapatuloy ang order kung mayroon akong logo upang i-print?

A: Una, maghahanda kami ng likhang sining para sa visual na kumpirmasyon. Kung ang kulay at posisyon ay tama, gagawin namin una ang sampling mula sa pabrika ng sutla na naka-print at kumuha ng litrato para sa iyong pangalawang kumpirmasyon bago ang mass production.

***Paano makipag-ugnay sa amin?
I-click ang ipasok magpadala sa amin ng tanong sa
ibaba.***