

## Sensor magnético de contato de metal da porta do obturador



### O PRINCIPAL PARÂMETRO DO EB-137A

<b>Nome do Produto:</b>	Sensor magnético de contato de metal da porta do obturador
<b>Número do modelo:</b>	EB-137A
<b>Tensão de trabalho:</b>	Max DC 100
<b>Corrente de trabalho:</b>	Máximo 0,5A
<b>Consumo de energia:</b>	10W
<b>Porta de interface:</b>	NC / COM
<b>Lacuna de indução:</b>	20 ~ 30mm
<b>Tamanho:</b>	Parte Reed: 106 * 38 * 10 (mm) Parte do ímã: 106* 16 * 16 (mm)
<b>Característica:</b>	<b>Uso da porta do obturador</b>
<b>Adequado para:</b>	<b>Todos os tipos de sistema de controle de acesso porta e sistema de alarme</b>
<b>Material:</b>	Carcaça ABS + placa PCB + interruptor Reed
<b>Cor da carcaça:</b>	Prata
<b>Peso:</b>	1 pares por saco, por saco de peso 220g

<b>Garantia:</b>	2 anos de garantia
<b>OEM:</b>	Bem-vindo OEM

**FEATURE SHOW DE EB-137A**

**Waterproof**

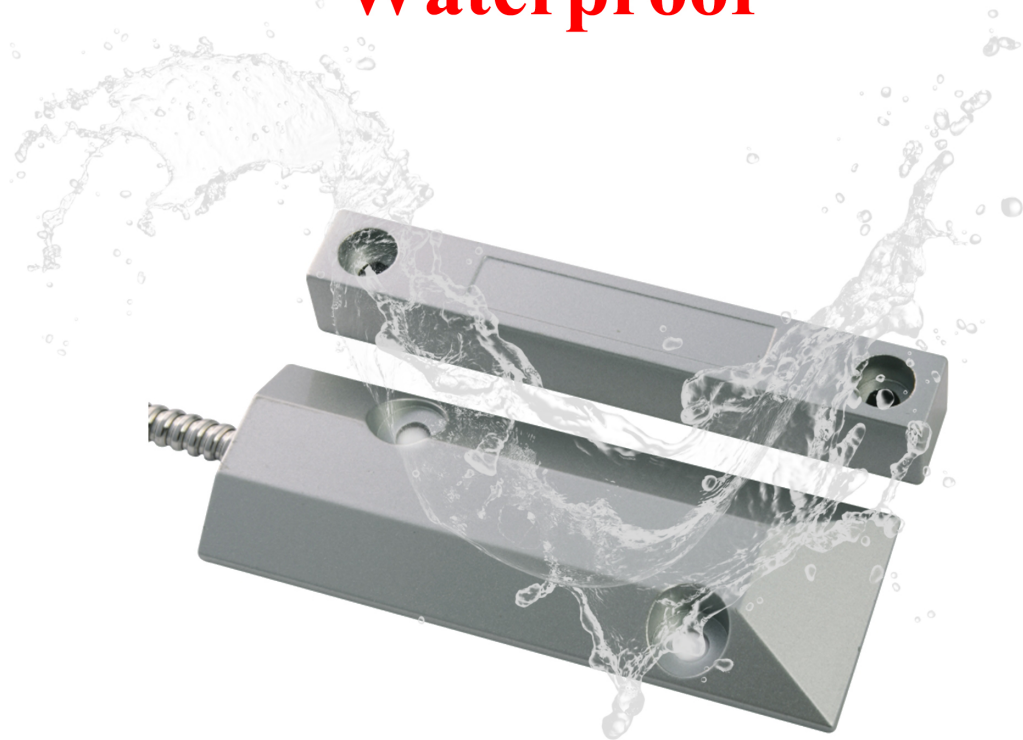

**Size**

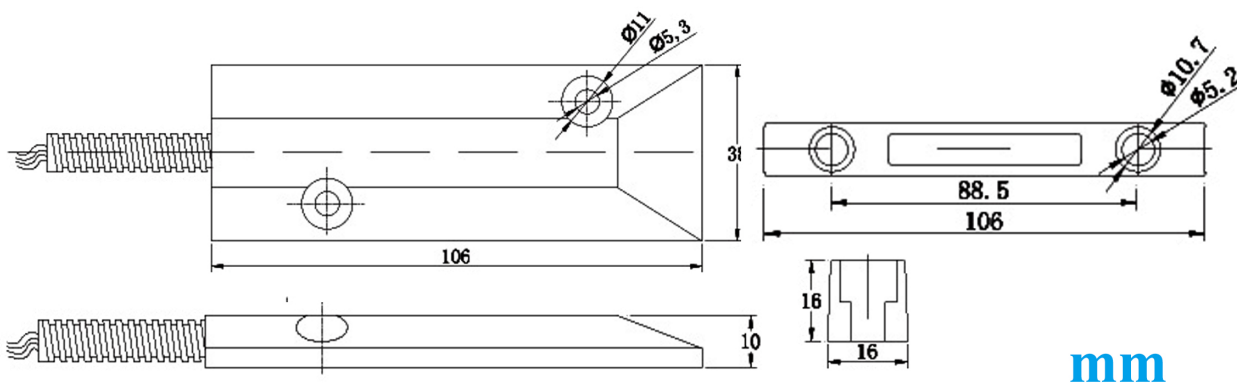
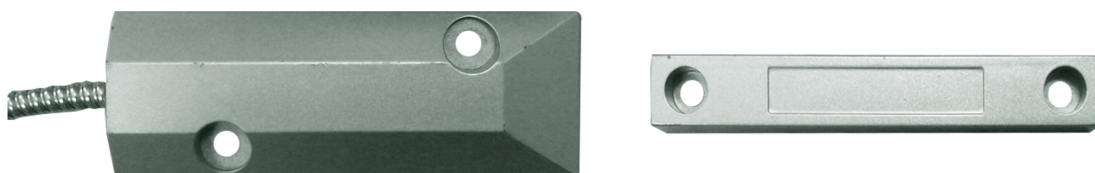

**mm**







# NC mode working principle

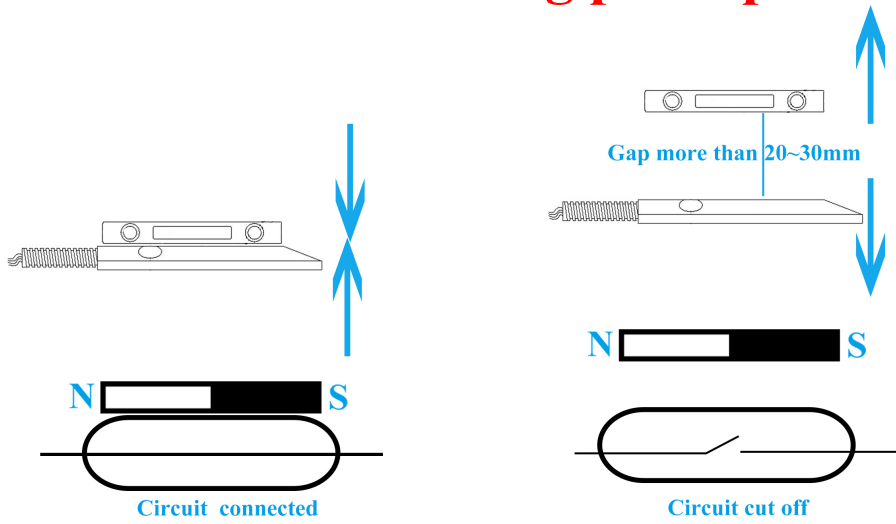

# Installation

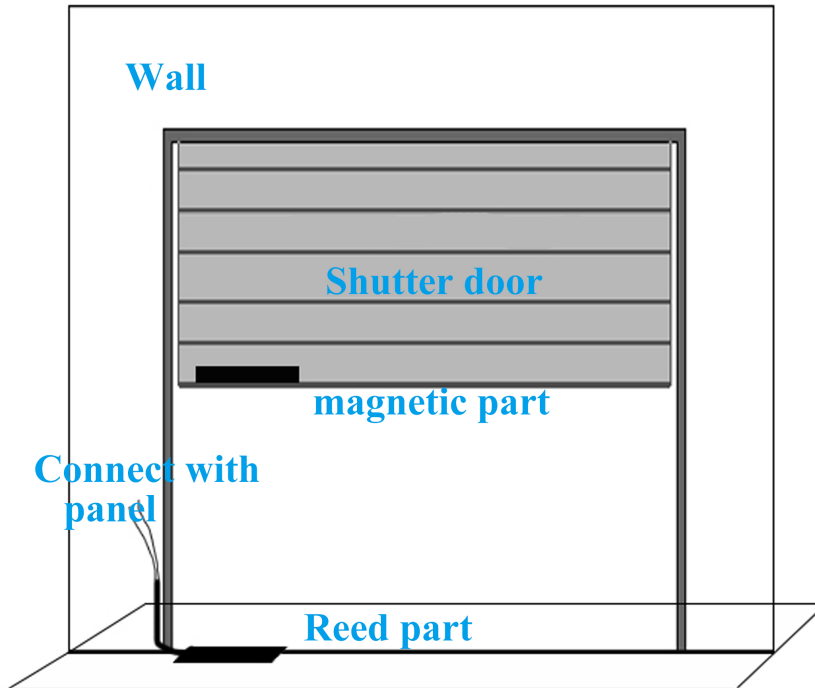

# Packaging



1pairs per bag

## COMO SOBRE OUTRA ESCOLHA?

SMQT<sup>®</sup>  
铭汗科技



SMQT<sup>®</sup>  
铭汗科技

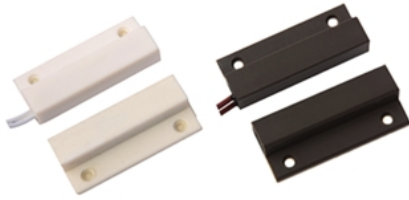

SMQT<sup>®</sup>  
铭汗科技

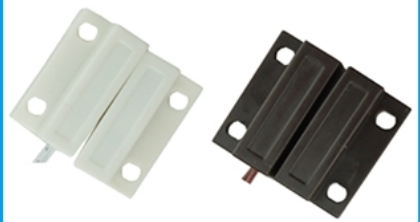

SMQT<sup>®</sup>  
铭汗科技

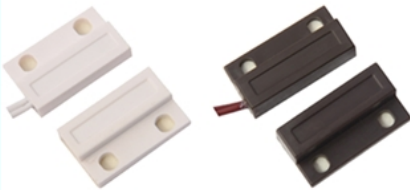

SMQT<sup>®</sup>  
铭汗科技



SMQT<sup>®</sup>  
铭汗科技

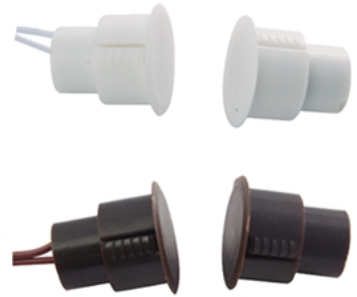

SMQT<sup>®</sup>  
铭汗科技



SMQT<sup>®</sup>  
铭汗科技



SMQT<sup>®</sup>  
铭汗科技

